

Simply a question of
better measurement



SCHMIDT[®] LED Measured Value Display
MD 10.010
Instructions for Use

SCHMIDT® LED Measured Value Display

MD 10.010

Table of Contents

1	Important information.....	3
2	Application range.....	4
3	Mounting instructions.....	4
4	Electrical connection.....	6
5	Signalizations	8
6	Startup	9
7	Configuration menu	15
8	Service information.....	19
9	Technical data	20
10	Declarations of conformity.....	21

Imprint:

Copyright 2022 **SCHMIDT Technology GmbH**

All rights reserved

Version: 531010.02E

Subject to modifications

1 Important information

These instructions for use contain all required information for a fast commissioning and a safe operation of **SCHMIDT®** LED measured value displays:

- These instructions for use must be read completely and observed carefully, before putting the unit into operation.
- Any claims under the manufacturer's liability for damage resulting from non-observance or non-compliance with these instructions will become void.
- Tampering with the device in any way whatsoever - with the exception of the designated use and the operations described in these instructions for use - will forfeit any warranty and exclude any liability.
- The unit is designed exclusively for the use described below (refer to chapter 2). In particular, it is not designed for direct or indirect protection of personal or machinery.
- **SCHMIDT Technology** cannot give any warranty as to its suitability for certain purpose and cannot be held liable for errors contained in these instructions for use or for accidental or sequential damage in connection with the delivery, performance or use of this unit.

Symbols used in this manual

The symbols used in this manual are explained in the following section.



Danger warnings and safety instructions. Read carefully!

Non-observance of these instructions may lead to injury of personal or malfunction of the device.



High voltage hazard – risk of life.



ESD susceptible elements (electrostatic discharge).

General note

All dimensions are indicated in mm.

2 Application range

The **SCHMIDT® LED Measured Value Display MD 10.010** (article no.: 527320 and 528240) is used to display measured values which are transmitted by a sensor via an analog signal (current or voltage).

The supply voltage of the sensor can be obtained from the LED display. Switching points for two alarm outputs can also be derived from the input signal. The galvanically isolated analog output allows the scalable output of the display values.

The **SCHMIDT® LED Measured Value Display MD 10.010** can be used for **SCHMIDT®** flow sensors as well as for other sensors (e.g. pressure, temperature, humidity) which are equipped with standard analog outputs.

The **SCHMIDT® LED Measured Value Display MD 10.010** is designed for the use inside closed rooms and is not suitable for outdoor use (risk of condensation on electronic parts). Moreover, the use in safety relevant applications is not allowed.

3 Mounting instructions

Dimensions

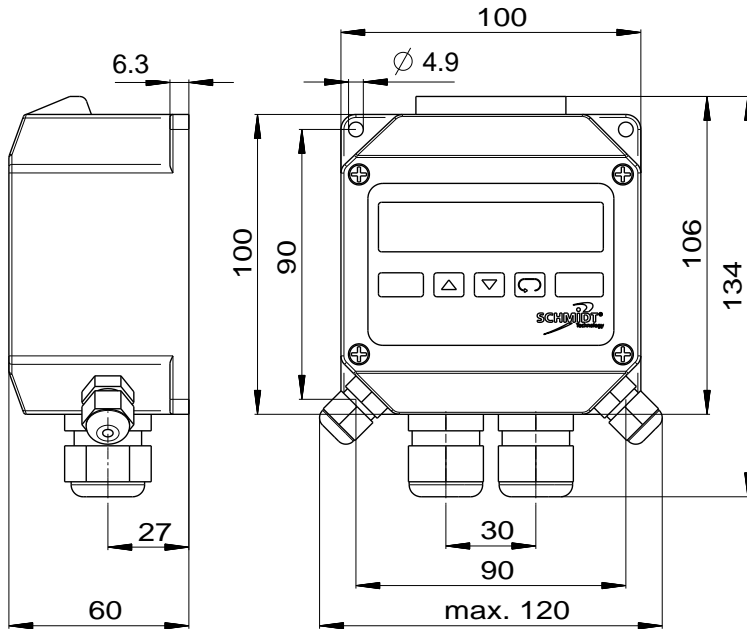

Figure 1: Dimensions of housing

Mounting

Typically, the **MD 10.010** is fixed to a wall by means of four screws (pattern of drilling see Figure 1).

Alternatively, **SCHMIDT Technology** offers a mounting kit that enables an easy installation of the device at pipes using hose clamps (article no. 531394).

Generally, please make sure that there is enough space (approx. 11 cm) to raise the upper part of the opened housing in order to establish electrical connection.

Lateral compression fittings

After installation of the measured value display, the compression fittings (included in delivery) can be mounted instead of the dummy plugs, if required.

Opening of housing

To establish electrical connection, the housing must be opened.



During electrical installation, ensure that no operating voltage is applied and its inadvertent activation is not possible.

For this, loose the four screws of the housing completely. After that, the screws should be pulled out as far as possible and fixed with a further left turn in the lid so that they cannot slip back and thus block the opening of the lid.

Inside the open housing, some components that are susceptible to ESD are not protected against unintentional contact. Though the terminals are resistant to ESD, the other touchable parts of the electronic system (e.g. cover board with configuration jumper, see Figure 3) are susceptible.



Take respective protective measures to avoid damages due to electrostatic discharge (ESD).

4 Electrical connection



The model **527320** uses low voltage (**115 / 230 VAC**).
If used improperly **danger of life!**



During electrical installation ensure that no supply voltage is applied and inadvertent activation is not possible.



Only trained and qualified personnel must carry out the electrical installation.

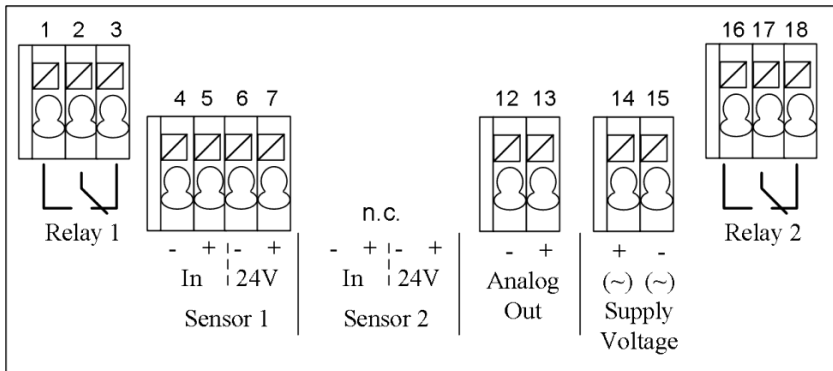

Figure 2: Terminals

Terminal	Designation	Function
1 - 3	Relay 1	Alarm output 1 (max. 250 VAC / 5 A)
4	Sensor 1: In-	Analog input 1: Sensor signal GND ¹
5	Sensor 1: In+	Analog input 1: Sensor signal (set jumper for configuration of signal modus)
6	Sensor 1: 24V -	Supply voltage of sensor: GND
7	Sensor 1: 24V+	Supply voltage of sensor: +24 VDC
12	Analog Out -	AGND (galvanically isolated from GND)
13	Analog Out+	Analog output (galvanically isolated)
14 - 15	Supply voltage display	Version DC: (14) +24V, (15) GND Version AC: (14) ~, (15) ~
16 - 18	Relay 2	Alarm output 2 (max. 250 VAC / 5 A)

Table 1: Pin assignment

The screwless spring terminals are designed for the reception of bare braids (no tinned ends or vein sleeves) of up to 1.5 mm².

¹ The potential "GND" is internally electrically coupled (but not "AGND").

Operating voltage

For proper operation, the **MD 10.010** requires depending of its version:

- Material No. 527320: 85 ... 250 VAC / 50 ... 60 Hz
- Material No. 528240: 23 ... 29 VDC



Only operate the measured value display within the defined operating voltage range and type.

The product can be destroyed; in worst case, **life is in danger**.

Supply voltage for sensor

The measurement display provides a voltage source for the supply of a sensor (or even several sensors). The supplied voltage U_{Sensor} is nominal 24 VDC, its tolerance is type depending:

- Material No. 527320: $U_{\text{Sensor}} = 24 \text{ V} \pm 15 \%$
- Material No. 528240²: $U_{\text{Sensor}} = U_{\text{Operating_Display}} - (1.2 \text{ V} + 25 \Omega \cdot I_{\text{Sensor}})$

The load current I_{Sensor} is limited to 160 mA.

Analog input

The jumper in the housing cover (see Figure 3) selects the signal characteristic (mode) of the analog input of the display (current or voltage).

If the bridge is placed on the left contact pin pair (*Voltage*) a voltage signal is expected. If the plug connects the right pair of pins (*Current*), a current signal must be active.

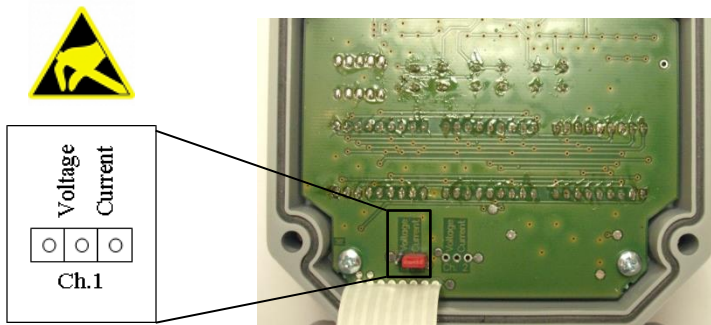

Figure 3: Jumper in housing cover for selecting input signal mode

The input resistance is mode dependent:

- Current mode: $R_{\text{IN}} = 200 \Omega$
- Voltage mode: $R_{\text{IN}} = 12.5 \text{ k}\Omega$

² Supply voltage of display is connected through, with a series diode & resistance of 25 Ω .

Analog output

The analog output of the **MD 10.010** is galvanically isolated from its own energy supply and the sensor supply (pin 13: *Analog Out+*; pin 12: *Analog Out-* \triangleq AGND; see Figure 2).

When using the display version with DC supply (24 V), the mass of the analog output (AGND) can be connected to that of the operating voltage (GND). However, the galvanic isolation is lost and a possible mass offset in the connecting cable can lead to a distortion of the output signal.

When using the display version with AC supply, the analog output must not be in contact with the supply voltage under any circumstances.

The load resistance R_L has to be connected to AGND:

- Current mode: $R_L \leq 400 \Omega$
- Voltage mode: $R_L \geq 1 \text{ k}\Omega$

In the configuration menu, beginning of signalization range without (0 mA or 0 V) or with offset (signal transmitting zero point: 4 mA) can be selected.

5 Signalizations

Main display

Initially, the main display (see Figure 4) shows the status of the device:

Main display	State
<i>i n i t</i>	Initialization of measured value display Duration approx. 5 s (after switch-on of supply voltage)
<i>l o c</i>	Key lock activated
<i>E r r o r</i>	Error message from sensor
<i>Flashing</i>	Displayable range exceeded or undercut

Table 2 Initial status reports

Analog output

If the connected sensor indicates an error, the analog output of the display **MD 10.010** will also signal an error:

- Signal area without offset (0 ... 20 mA / 0 ... 10 V):
In current mode the interface outputs 0 mA.
In voltage mode the output switches to 0 V.
- Signal area with offset (4 ... 20 mA):
The interface outputs 2 mA.

6 Startup

Before switching on the **SCHMIDT® Measured Value Display MD 10.010**, check whether the device is intact as well as installed correctly, both mechanically and electrically.

If the display is in the correct operational state, it is ready for operation approx. 5 seconds after switching on the supply voltage.

Operating and display elements

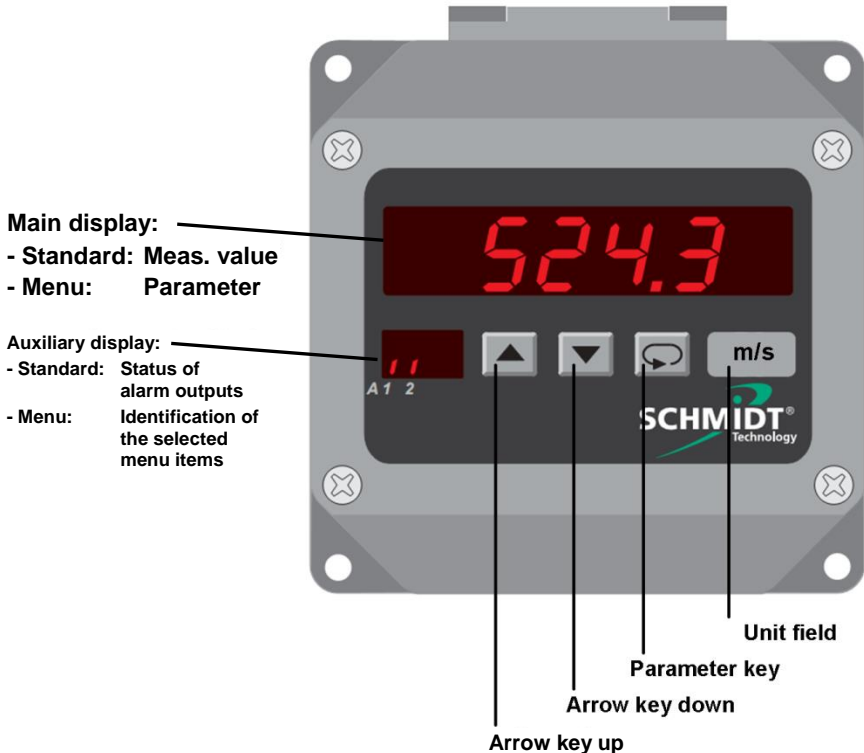

Figure 4: Operating and display elements

The labels included in the delivery can be attached to the unit field to indicate the desired measuring unit (e.g. m/s, m³/h ...) of the main display.

Standard mode

After a successful initialization phase, the **MD 10.010** enters its standard operation mode as “Measured value display” (see Figure 4).

The main display shows the actual standard measurement value, the status of the alarm outputs are depicted in the auxiliary display (see Table 3).





Auxiliary display	State
	Alarm output 1: Not activated Alarm output 2: Not activated
	Alarm output 1: Activated Alarm output 2: Not activated
	Alarm output 1: Not activated Alarm output 2: Activated
	Alarm output 1: Activated Alarm output 2: Activated



Table 3 Alarm indication

Handling

The device can be operated by means of two different menus which are activated from standard mode using the parameter key :

- Shortly press the parameter key to open the display menu.
In this menu, the actual measured values of “Sensor 1”, the stored peak values (minimum and maximum) of the standard value as well as the switching points of the alarm outputs can be sequentially displayed by further pressing of the parameter key.
If the key isn't pressed for more than 2 minutes, the device returns automatically to standard mode.
- If the parameter key is pressed for more than 2 seconds, the configuration menu opens.

It can be used to configure the measuring input (sensor signal), both alarm outputs and the analog output (details see chapter 7).

The menu items are selected sequentially by using the parameter key (short press). The settings of the currently selected menu item can be modified using the arrow keys ( .

The configuration menu is closed after the last menu item or, if no key is pressed for more than two minutes, it is exited automatically. It can also be quitted at any time by pressing the parameter key for a longer time (more than 2 seconds).

Table 4 shows an overview of the presentation and meaning of the different menu items in the auxiliary display.

Example application 1 – step by step

With a flow sensor (measuring range: 40 m/s; output signal: 4 ... 20 mA) the flow velocity shall be indicated in m/s. The analog output of the display shall signal a scaled measuring range from 1 m/s (\cong 4 mA) up to 20 m/s (\cong 20 mA). If the flow velocity exceeds 15 m/s an alarm signal is issued over relay 1, without hysteresis or delays.

- Install LED display at desired position
- Plug jumper in housing cover for “current measurement”
- Connect supply voltage of sensor to LED display
- Connect analog output of sensor to LED display
- Connect analog output and relay output 1 of LED display
- Connect supply voltage of LED display and close its housing
- After switching on the supply voltage:

Initialization, followed by indication of an “unconfigured“ measurement value on the main display



- Call-up configuration menu by pushing  for 2 seconds

Auxiliary display	Main display	Description
F 1	oFF	Averaging of measuring value: Deactivated
Configuration of analog input		
n 1	4 - 20	➤ Signal mode: 4 ... 20 mA
d 1	0000.00	➤ Accuracy of indication: 2 decimals
S 1	0.00	➤ Start value: 0 m/s (\cong 4 mA)
E 1	40.00	➤ End value: 40 m/s (\cong 20 mA)
Configuration of alarm output 1		
Y 1	on	➤ Alarm output: Activated
Y 2	onr	➤ Switching mode: Active when exceeding
Y 3	15.00	➤ Switching point: 15 m/s
Y 4	0.00	➤ Switching hysteresis: 0 m/s
Y 5	0.00.00	➤ Response delay: 0 s
Y 6	0.00.00	➤ Release delay: 0 s
Configuration of alarm output 2		
Z 1	oFF	Alarm output: Deactivated

Auxiliary display	Main display	Description
Configuration of analog output		
o5	on	➤ Analog output: Activated
no	4 - 20	➤ Signal mode: 4 ... 20 mA
5o	1.00	➤ Start value: 1 m/s (\pm 4 mA)
Eo	20.00	➤ End value: 20 m/s (\pm 20 mA)
Lc	oFF	Control panel lock: Deactivated

After the final menu item, the configuration menu is left automatically going back to the main display.

- Verification of indication values in display menu (short press of )

Auxiliary display	Main display	Description
ii	12.80	Actual measured value of sensor: 12.80 m/s
r l	9.120	Actual raw signal value of sensor : 9.120 mA
PP	35.80	Peak-value memory: - Maximum measured value of sensor: 35.80 m/s - Deletion of stored value by using  for approx. 5 s
nP	1.80	Peak-value memory: - Minimal measured value of sensor. 1.80 m/s - Deletion of stored value by using  for approx. 5 s
R 1	15.00	Switching point of alarm output A1: 15.00 m/s
R2	oFF	Alarm output A2: Deactivated

After the final menu item, the display menu is left automatically going back to the main display.

Example application 2 – step by step

A flow sensor (measuring range: 60 m/s; output signal: 4 ... 20 mA) is installed into a tube with DN 50. Using the unfiltered measurement value of flow velocity w_N , the volume flow shall be calculated and displayed as primary value (in m³/h).

The analog output of the display shall use 4 ... 20 mA to signal a scaled volume flow: 4 mA \triangleq 0 m³/h and 20 mA \triangleq 200 m³/h.

In addition, a switching signal, delayed by 30 seconds is required as soon as 150 m³/h are exceeded, the hysteresis is 10 m³/h.

- Determination of the maximum volume flow based on the maximum flow velocity and the pipe diameter: 60 m/s \triangleq 343 m³/h

Available from the sensor's instruction manual or by means of the **SCHMIDT**[®] flow calculator:

www.schmidt-sensors.com/stroemungsrechner/volumenstrom-geschwindigkeit.html



- Install LED display in desired position
- Plug jumper in housing cover for "current measurement"
- Connect supply voltage of sensor to LED display
- Connect analog output of sensor to LED display
- Connect analog output and relay output 1 of LED display
- Connect supply voltage of LED display and close its housing
- After switching on the supply voltage:
Initialization, followed by indication of an "unconfigured" measurement value on the main display
- Call-up of configuration menu by pushing  for 2 seconds

Auxiliary display	Main display	Description
<i>F 1</i>	<i>OFF</i>	Averaging of measurement value: Deactivated
Configuration of analog input		
<i>n 1</i>	<i>4 - 20</i>	➤ Signal mode: 4 ... 20 mA
<i>d 1</i>	<i>00000.0</i>	➤ Accuracy of indication: 1 decimal
<i>S 1</i>	<i>0.0</i>	➤ Start value: 0 m ³ /h (\triangleq 4 mA)
<i>E 1</i>	<i>343.0</i>	➤ End value: 343 m ³ /h (\triangleq 20 mA)
Configuration of alarm output 1		
<i>y 1</i>	<i>on</i>	➤ Alarm output: Activated
<i>y 2</i>	<i>onr</i>	➤ Switching mode: Active when exceeding
<i>y 3</i>	<i>150.0</i>	➤ Switching point: 150 m ³ /h

Auxiliary display	Main display	Description
44	10.0	➤ Switching hysteresis: 10 m ³ /h (relay declines in case of a decrease below 140 m ³ /h)
45	0.00.30	➤ Response delay: 30 s
46	0.00.30	➤ Release delay: 30 s
Configuration of alarm output 2		
21	oFF	Alarm output: Deactivated
Configuration of analog output		
o5	oN	➤ Analog output: Activated
n0	4 - 20	➤ Signal mode: 4 ... 20 mA
S0	0.0	➤ Start value: 0 m ³ /h (± 4 mA)
E0	200.0	➤ End value: 200 m ³ /h (± 20 mA)
Lc	oFF	Control panel lock: Deactivated

After the final menu item, the configuration menu is left automatically going back to the main display.

- Verification of indication value on display menu (short press of )

Auxiliary display	Main display	Description
11	120.8	Actual measured value of sensor: 120.8 m ³ /h
r1	9.635	Actual raw signal of sensor: 9.635 mA
PP	305.0	Peak-value memory: - Maximum measured value of sensor: 305.0 m ³ /h - Deletion of stored value by using  for approx. 5 s
nP	10.7	Peak-value memory: - Minimum measured value of sensor: 10.7 m ³ /h - Deletion of stored value by using  for approx. 5 s
R1	150.0	Switching point of alarm output A1: 150.0 m ³ /h
R2	oFF	Alarm output A2: Deactivated

After the final menu item, the display menu is left automatically going back to the main display.

7 Configuration menu

Information regarding presentation

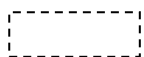

Menu item is only displayed if the respective configuration is selected

Flow diagram

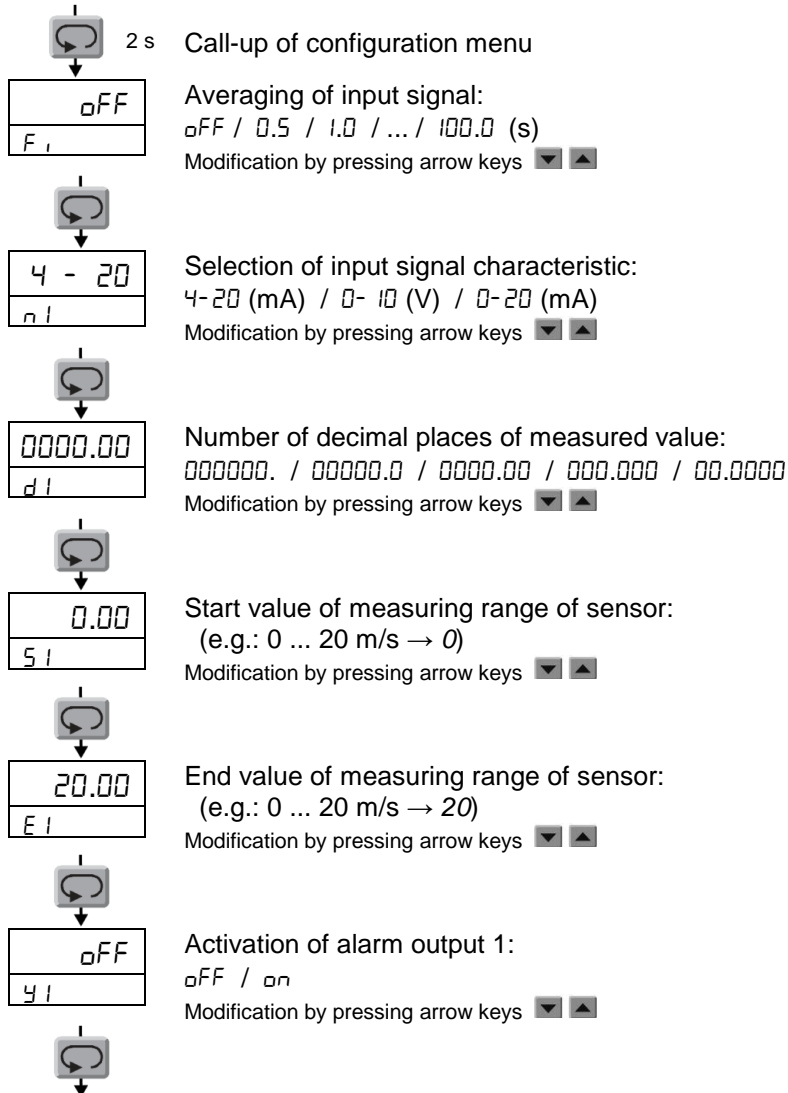

oNn
42

Switching behaviour of alarm output 1:

oNn (switches when switching point is exceeded) /

oNl (switches when dropping below switching point)

Modification by pressing arrow keys ▼ ▲



5.00
43

Switching point of alarm output 1:

Modification by pressing arrow keys ▼ ▲



0.50
44

Hysteresis of alarm output 1 (four digits):

Modification by pressing arrow keys ▼ ▲



0.00.00
45

Response delay of alarm output 1:

0.00.00 ... 9.00.00 (h.mm.ss)

Modification by pressing arrow keys ▼ ▲



0.00.00
46

Release delay of alarm output 1:

0.00.00 ... 9.00.00 (h.mm.ss)

Modification by pressing arrow keys ▼ ▲



oFF
21

Configuration of alarm output 2:

Identical to alarm output 1 (menu items: 22 ... 25)



oFF
o5

Activation of analog output:

oFF / on

Modification by pressing arrow keys ▼ ▲



4 - 20
no



Signal mode of analog output:

4-20 (mA) / 0-10 (V) / 0-20 (mA)

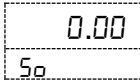

Modification by pressing arrow keys ▼ ▲



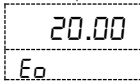

Start value for displayed range of analog output:
Number of decimal places is defined by configuration of
the reference signal for main display (menu item *d l*)
Modification by pressing arrow keys  



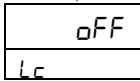

End value for displayed range of analog output:
Number of decimal places is defined by configuration of
the reference signal for main display (menu item *d l*)
Modification by pressing arrow keys  



Key lock:

0FF / 0n

Modifications in configuration menu as well as reset of
peak value memory are locked

Modification by pressing arrow keys  , even if "key lock" is
active

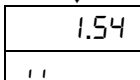

Return to main display

Menu overview

The following Table 4 shows the representation of all possible menu items in the auxiliary display (see Figure 4).

Auxiliary display	Display / parameter
<i>i i</i>	Indication main display: Actual measured value [m/s, m ³ /h, °C ...]
<i>A 1</i>	Indication display menu: Switching point of alarm output 1
<i>A 2</i>	Indication display menu: Switching point of alarm output 2
<i>d 1</i>	Decimals of input signal
<i>E 1</i>	End value of input signal
<i>E o</i>	End value of output signal
<i>F 1</i>	Value averaging
<i>L c</i>	Operation lock
<i>n 1</i>	Signal mode of input signal
<i>n o</i>	Signal mode of analog output
<i>n P</i>	Indication display menu: Minimum measured peak value
<i>o 5</i>	Activation of analog output
<i>P P</i>	Indication display menu: Maximum measured peak value
<i>r 1</i>	Indication display menu: Raw value of input signal
<i>S 1</i>	Start value of input signal
<i>S o</i>	Start value of analog output
<i>y 1</i>	Indication display menu: Activation of alarm output 1
<i>y 2</i>	Switching behaviour of alarm output 1
<i>y 3</i>	Indication display menu: Switching point of alarm output 1
<i>y 4</i>	Hysteresis of alarm output 1
<i>y 5</i>	Response delay of alarm output 1
<i>y 6</i>	Release delay of alarm output 1
<i>z 1</i>	Indication display menu: Activation alarm of output 2
<i>z 2</i>	Switching behaviour of alarm output 2
<i>z 3</i>	Indication display menu: Switching point of alarm output 2
<i>z 4</i>	Hysteresis of alarm output 2
<i>z 5</i>	Response delay of alarm output 2
<i>z 6</i>	Release delay of alarm output 2

Table 4

8 Service information

Eliminating malfunctions

The following Table 5 lists possible errors (error images).

A description of the way to detect errors is given. Furthermore, the possible causes and measures to be taken to eliminate errors are listed.

Error image	Possible causes	Troubleshooting
Displays off & analog output to zero	Supply voltage U_B : <ul style="list-style-type: none"> ➤ No U_B present ➤ U_B (DC) wrong polarity ➤ U_B too low LED Display defective	Supply voltage: <ul style="list-style-type: none"> ➤ Check if connected correctly to power supply ➤ Check voltage type (DC, AC) ➤ Check if there is supply voltage at the terminal (cable break)
Measuring range too large / small	Incorrect configuration of sensor's measuring range	<ul style="list-style-type: none"> ➤ Check if analog measured value is correct (r !) ➤ Check configuration of start (S !) ➤ Check end value (E !) of sensor's measuring range
Analog measuring value (r !)	Jumper of signal mode analog input	➤ Set jumper according signal mode
	Input configuration	➤ Check input configuration (r !)
Analog signal too large / small	Output configuration	➤ Check configuration
Unexpected values at alarm output	Configuration alarm output	➤ Check configuration

Table 5

9 Technical data

Technical data	
Displays	Main display: 7-segments LED red; 14.2 mm; 6 digits Sub display: 7-segments LED red; 7 mm; 2 digits
Input signal	Current: 0 / 4 ... 20 mA ($R_{IN} = 200 \Omega$) Voltage: 0 ... 10 V ($R_{IN} = 12,5 \text{ k}\Omega$)
Analog output	Galvanically isolated, short-circuit protected Permissible load resistance R_L in signal mode: Voltage ³ (0 ... 10 V): $R_L \geq 1 \text{ k}\Omega$ Current (0 / 4 ... 20 mA): $R_L \leq 400 \Omega$
Accuracy of analog output	$\pm 0.2 \%$ of measured value
Relay outputs	2 x relay with changeover contacts (SPDT, potential-free) Max. 250 VAC / 5 A
Voltage supply for sensor	Short-circuit protected; current limited to max. 160 mA Mat.-no. 527320: 24 VDC $\pm 15 \%$ Mat.-no. 528240 ⁴ : See "Supply voltage for sensor" (p. 7)
Supply voltage of display	Mat. no. 527320: 85 ... 250 VAC / 50 ... 60 Hz Mat. no. 528240: 23 ... 29 VDC
Power consumption of display	Max. 8 VA
Operating temperature	-20 ... +60 °C
Storage/transport temperature	-40 ... +70 °C
Environmental conditions	Up to 95 % RH (non-condensing)
Connection	14 x spring clamps, bare braid, $\varnothing \leq 1.5 \text{ mm}^2$ 4 x compression fittings
Operating position	Arbitrary
Ingress protection	IP65 (housing and screw connections tightly sealed)
Protection class	II (touch proofed)
Housing material	Polyamide, glass-fibre reinforced (PA6-GF 15/15), colour similar to RAL 7001
Weight	Approx. 370 g

Table 6

³ Current limited

⁴ Supply voltage of display is connected through, with a series diode & resistance of 25 Ω .

10 Declarations of conformity

SCHMIDT Technology GmbH herewith declares in its sole responsibility, that the product

SCHMIDT® LED Measured value Display MD 10.010

Part-Nos. **527 230** and **528 240**

is in compliance with the appropriate



European guidelines and standards

and



UK statutory requirements and designated standards.

The corresponding declarations of conformity can be download from **SCHMIDT®** homepage:

www.schmidt-sensors.com

www.schmidttechnology.de

Notes

Notes



SCHMIDT Technology GmbH

Feldbergstraße 1
78112 St. Georgen
Germany

Phone +49 (0)7724 / 899-0

Fax +49 (0)7724 / 899-101

Email sensors@schmidttechnology.de

URL www.schmidt-sensors.com
www.schmidttechnology.de